

CHILLED DICER

WHS-CD160

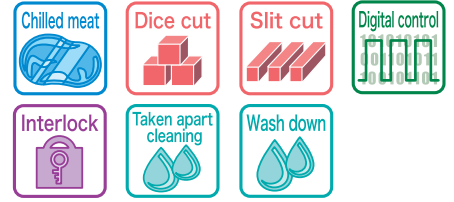

Only one unit is needed for your chicken dice cut.

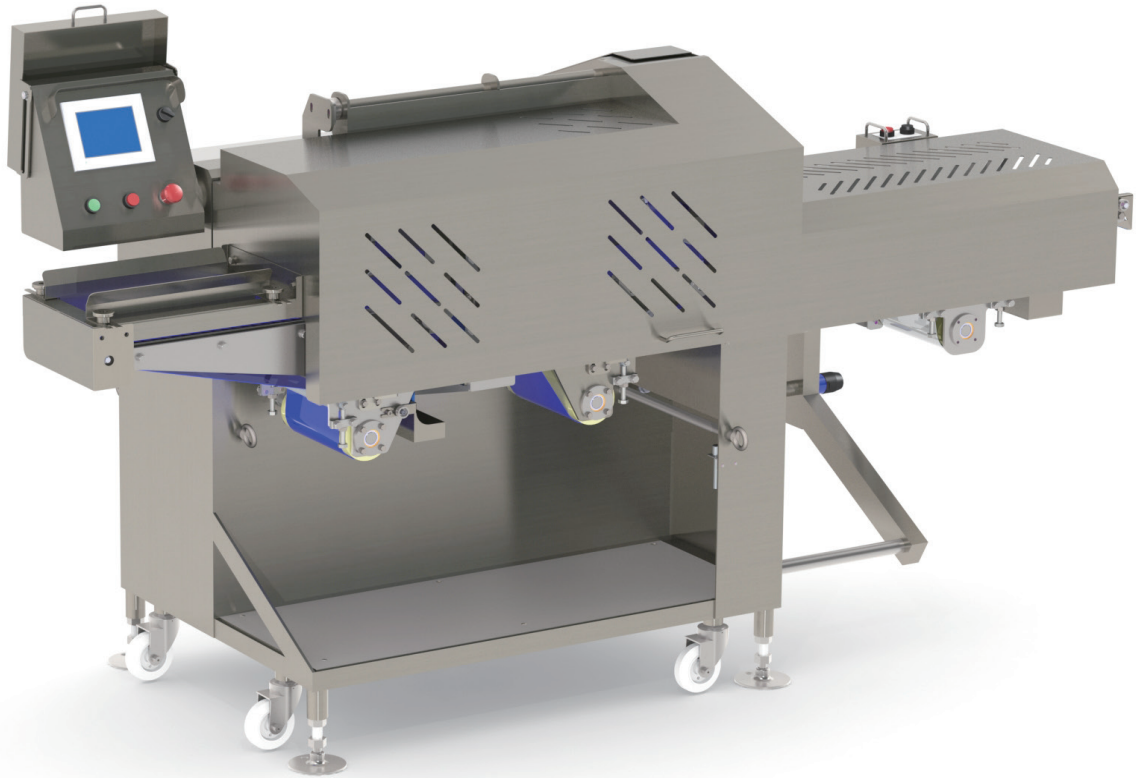

smart
division

SMART DIVISION

Use edge meat effectively by smart division function. Maximize product yield.

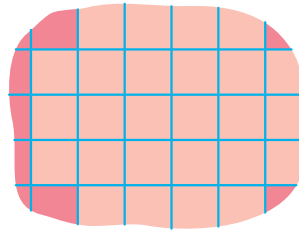

With smart division

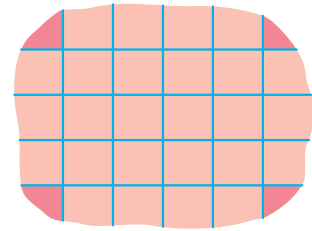

Without smart division ● Loss

EASY-TO-OPERATION & SIMPLE TOUCH PANEL

Operation item is able to be set in the program. Everyone can operate easily. Machine can operate both "Dice cut mode" and "Slit cut mode" It helps to make variety of products.



BLADE CASSETTE

1st cut, it can adjust by replacing the blade cassette. (Changeable from 10mm pitch in 5mm increments) 2nd cut, it can adjust by touch panel.

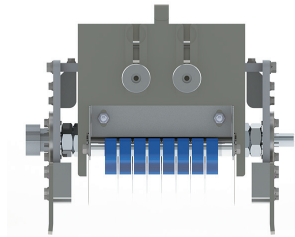

SAFETY

Inter lock systems are used for all covers. Reminders from the interlock systems can be checked by a touch panel for your safety.

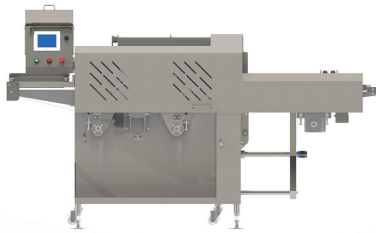

HYGIENE

Blades and conveyor belts are able to be disassembled. Machine can be washed down.



SPECIFICATION

| | |
|-------------------|--|
| DIMENSIONS | W2370xD880xH1425mm |
| WEIGHT | 420kg |
| MAX. SLICE SIZE | WW160xH10~45xL250(max length for smart division)mm |
| CUT LENGTH | 10~125mm (smart division) |
| CAPACITY | 250kg/h (Chicken thigh □30mm dice cut)*1 |
| SLICE TEMPERATURE | 0°C~+3°C (Depends on product) |
| RATED ELECTRICITY | Output: 2.42kW Pated electrical current: 18.4A |
| RATED CONSUMPTION | 0.25kW (50/60Hz with no load) |
| POWER SUPPLY | 3Ph 200V 50/60Hz more than 30A |

*1 Depends on the products and operation.

DRAWING

Please refer to the drawing for further information.

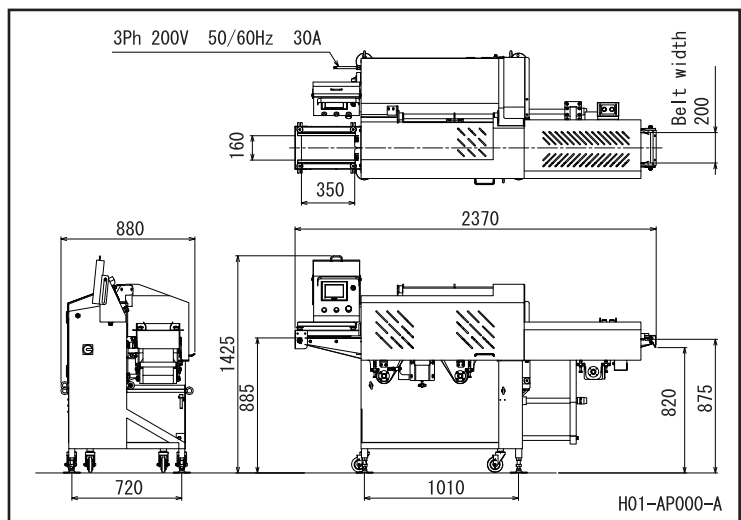

SALES AGENT

WATANABE

WATANABE FOODMACH CO.,LTD.

2-12-26 TSUYUHASHI NAKAGAWA-KU NAGOYA JAPAN

TEL052-361-8511 FAX052-361-8490

URL: <http://www.foodmach.co.jp/>

In the interests of improvement, the specifications and appearance of the product are subject to change without notice.

1703